



■ Features

- Constant Current mode output
- Metal housing with Class I design
- Built-in active PFC function
- IP67 / IP65 design for indoor or outdoor installations
- Function options: output adjustable via potentiometer; 3 in 1 dimming; Timer dimming
- Typical lifetime > 62000 hours
- 7 years warranty

■ Applications

- LED street lighting
- LED fishing lamp
- LED harbor lighting
- LED building architectural lighting
- LED bay lighting

■ Description

HLG-185H-C series is a 200W AC/DC LED power supply featuring the constant current mode and high voltage output. HLG-185H-C operates from 90~305VAC and offers models with different rated current ranging between 500mA and 1400mA. Thanks to the high efficiency up to 94%, with the fanless design, the entire series is able to operate for -40°C ~ +90°C case temperature under free air convection. The design of metal housing and IP67/IP65 ingress protection level allows this series to fit both indoor and outdoor applications. HLG-185H-C is equipped with various function options, such as dimming methodologies, so as to provide the optimal design flexibility for LED lighting system.

■ Model Encoding

HLG - 185H - C700 [A]

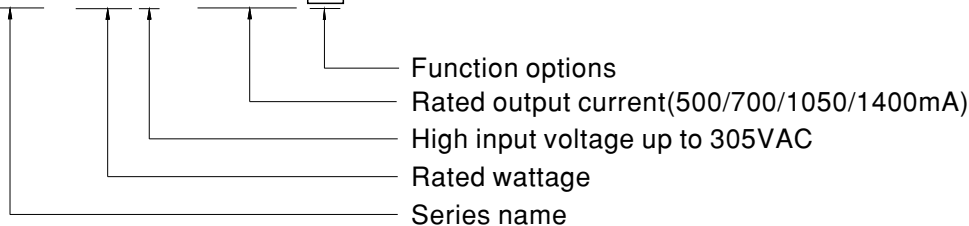

| Type | IP Level | Function | Note |
|------|----------|---|------------|
| A | IP65 | I _o adjustable through built-in potentiometer. | In Stock |
| B | IP67 | 3 in 1 dimming function (1~10Vdc, 10V PWM signal and resistance) | In Stock |
| AB | IP65 | I _o adjustable through built-in potentiometer & 3 in 1 dimming function (1~10Vdc, 10V PWM signal and resistance) | In Stock |
| D | IP67 | Timer dimming function, contact MEAN WELL for details(safety pending). | By request |



SPECIFICATION

| MODEL | | HLG-185H-C500 □ | HLG-185H-C700 □ | HLG-185H-C1050 □ | HLG-185H-C1400 □ |
|-----------------------------------|---|---|-----------------|------------------|------------------|
| OUTPUT | RATED CURRENT | 500mA | 700mA | 1050mA | 1400mA |
| | RATED POWER | 200W | 200.2W | 199.5W | 200.2W |
| | CONSTANT CURRENT REGION <small>Note.2</small> | 200V ~ 400V | 143V ~ 286V | 95V ~ 190V | 71V ~ 143V |
| | CURRENT ADJ. RANGE | Can be adjusted by internal potentiometer (A/AB type only) | | | |
| | | 250 ~ 500mA | 350 ~ 700mA | 525 ~ 1050mA | 700 ~ 1400mA |
| | CURRENT RIPPLE | 5.0% max. @rated current | | | |
| | CURRENT TOLERANCE | ±5% | | | |
| SET UP TIME <small>Note.4</small> | 1000ms/115VAC 500ms/230VAC | | | | |
| INPUT | VOLTAGE RANGE <small>Note.3</small> | 90 ~ 305VAC 127 ~ 431VDC (Please refer to "STATIC CHARACTERISTIC" section) | | | |
| | FREQUENCY RANGE | 47 ~ 63Hz | | | |
| | POWER FACTOR (Typ.) | PF ≥ 0.98/115VAC or PF ≥ 0.96/230VAC or PF ≥ 0.94/277VAC @full load (Please refer to "POWER FACTOR (PF) CHARACTERISTIC" section) | | | |
| | TOTAL HARMONIC DISTORTION | THD < 20% @ ≥ 50% load/115VAC, or 230VAC, or @ ≥ 75% load/277VAC (Please refer to "TOTAL HARMONIC DISTORTION" section) | | | |
| | EFFICIENCY (Typ.) | 94% | 94% | 94% | 94% |
| | AC CURRENT (Typ.) | 2A / 115VAC | 1A / 230VAC | 0.85A / 277VAC | |
| | INRUSH CURRENT(Typ.) | COLD START 55A(twidth=900μs measured at 50% Ipeak) at 230VAC; Per NEMA 410 | | | |
| | MAX. No. of PSUs on 16A CIRCUIT BREAKER | 2 units (circuit breaker of type B) / 3 units (circuit breaker of type C) at 230VAC | | | |
| | LEAKAGE CURRENT | <0.75mA / 277VAC | | | |
| PROTECTION | SHORT CIRCUIT | Constant current limiting, recovers automatically after fault condition is removed | | | |
| | OVER VOLTAGE | 450 ~ 470V | 320 ~ 340V | 210 ~ 225V | 160 ~ 170V |
| | OVER TEMPERATURE | Shut down o/p voltage, recovers automatically after temperature goes down | | | |
| ENVIRONMENT | WORKING TEMP. | Tcase=-40 ~ +90°C (Refer to "Derating Curve") | | | |
| | MAX. CASE TEMP. | Tcase=+90°C | | | |
| | WORKING HUMIDITY | 10 ~ 95% RH non-condensing | | | |
| | STORAGE TEMP., HUMIDITY | -40 ~ +80°C, 10 ~ 95% RH | | | |
| | TEMP. COEFFICIENT | ±0.03%/°C (0 ~ 50°C) | | | |
| | VIBRATION | 10 ~ 500Hz, 5G 12min./1cycle, period for 72min. each along X, Y, Z axes; | | | |
| SAFETY & EMC | SAFETY STANDARDS | UL8750, CSA C22.2 No. 250.13-12, EN/AS/NZS 61347-1, EN/AS/NZS 61347-2-13, EN62384 independent,GB19510.1,GB19510.14; IP65 or IP67, J61347-1, J61347-2-13, EAC TP TC 004 approved | | | |
| | WITHSTAND VOLTAGE | I/P-O/P:3.75KVAC I/P-FG:2KVAC O/P-FG:1.5KVAC | | | |
| | ISOLATION RESISTANCE | I/P-O/P, I/P-FG, O/P-FG:100M Ohms / 500VDC / 25°C / 70% RH | | | |
| | EMC EMISSION | Compliance to EN55015, EN61000-3-2 Class C (≥ 50% load) ; EN61000-3-3,GB17743 and GB17625.1,EAC TP TC 020 | | | |
| | EMC IMMUNITY | Compliance to EN61000-4-2,3,4,5,6,8,11, EN61547, heavy industry level (surge immunity Line-Earth 4KV, Line-Line 2KV),EAC TP TC 020 | | | |
| OTHERS | MTBF | 651.1K hrs min. Telcordia SR-332 (Bellcore) ; 191.9K hrs min. MIL-HDBK-217F (25°C) | | | |
| | DIMENSION | 228*68*38.8mm (L*W*H) | | | |
| | PACKING | 1.15Kg; 12pcs/14.8Kg/0.8CUFT | | | |
| NOTE | <p>1. All parameters NOT specially mentioned are measured at 230VAC input, rated current and 25°C of ambient temperature.</p> <p>2. Please refer to "DRIVING METHODS OF LED MODULE".</p> <p>3. De-rating may be needed under low input voltages. Please refer to "STATIC CHARACTERISTIC" sections for details.</p> <p>4. Length of set up time is measured at first cold start. Turning ON/OFF the driver may lead to increase of the set up time.</p> <p>5. The driver is considered as a component that will be operated in combination with final equipment. Since EMC performance will be affected by the complete installation, the final equipment manufacturers must re-qualify EMC Directive on the complete installation again.</p> <p>6. To fulfill requirements of the latest ErP regulation for lighting fixtures, this LED driver can only be used behind a switch without permanently connected to the mains.</p> <p>7. This series meets the typical life expectancy of >62,000 hours of operation when Tcase, particularly (Ⓢ) point (or TMP, per DLC), is about 75°C or less.</p> <p>8. Please refer to the warranty statement on MEAN WELL's website at http://www.meanwell.com.</p> <p>9. The ambient temperature derating of 3.5°C/1000m with fanless models and of 5°C/1000m with fan models for operating altitude higher than 2000m(6500ft).</p> <p>10. For any application note and IP water proof function installation caution, please refer our user manual before using. https://www.meanwell.com/Upload/PDF/LED_EN.pdf</p> | | | | |

■ DIMMING OPERATION

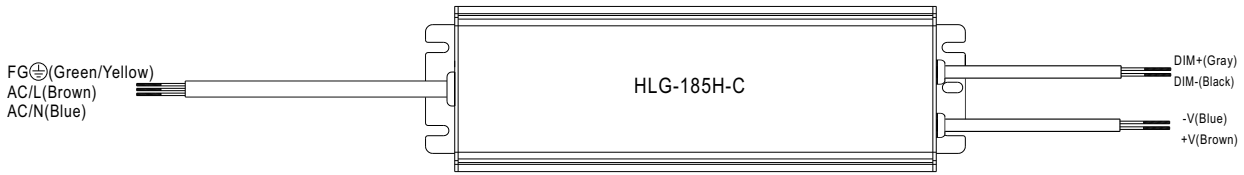

※ 3 in 1 dimming function (for B/AB-Type)

- Output constant current level can be adjusted by applying one of the three methodologies between DIM+ and DIM-: 1 ~ 10VDC, or 10V PWM signal or resistance.
- Direct connecting to LEDs is suggested. It is not suitable to be used with additional drivers.
- Dimming source current from power supply: 100 μ A (typ.)

◎ Applying additive 1 ~ 10VDC

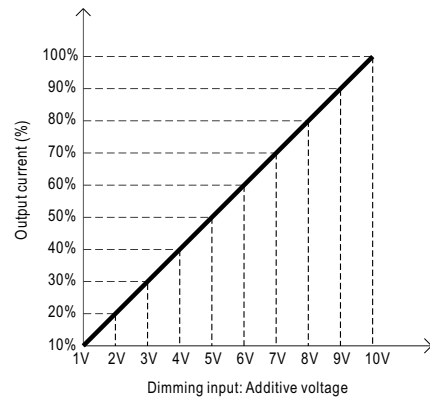
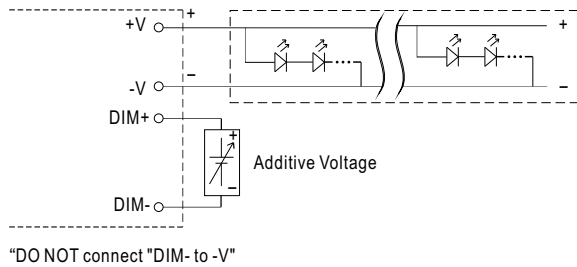

◎ Applying additive 10V PWM signal (frequency range 100Hz ~ 3KHz):

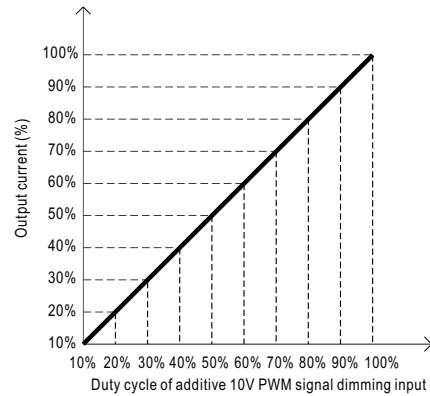
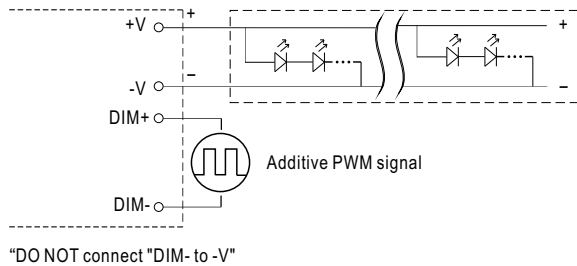

◎ Applying additive resistance:

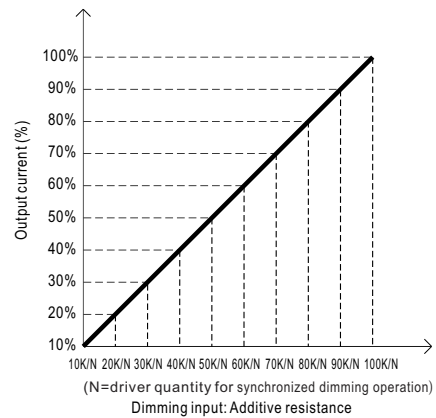
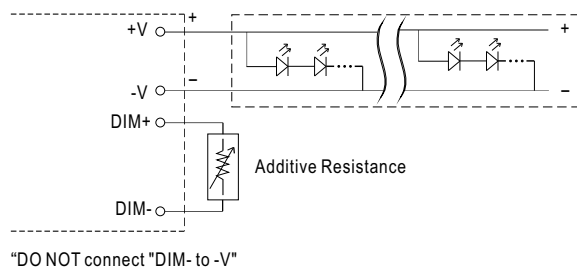

Note: In the case of turning the lighting fixture down to 0% brightness, please refer to the configuration as follow, or please contact MEAN WELL for other options.

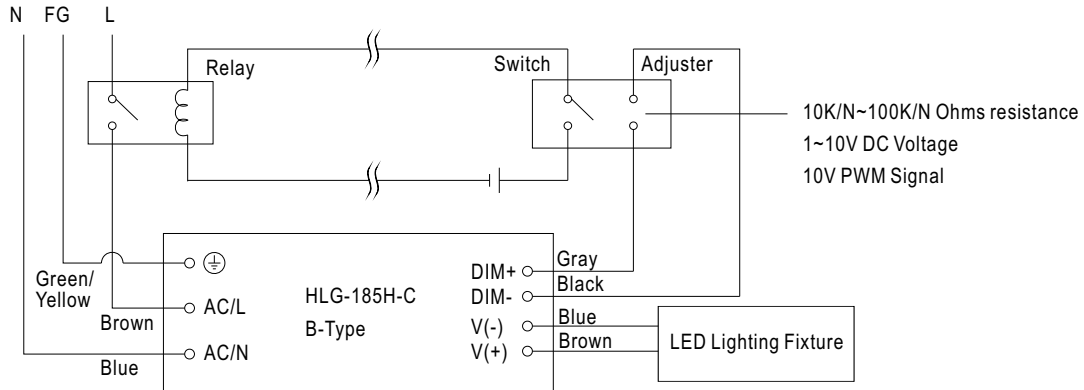

Using a switch and relay can turn ON/OFF the lighting fixture.

OUTPUT LOAD vs TEMPERATURE(Notes.8)

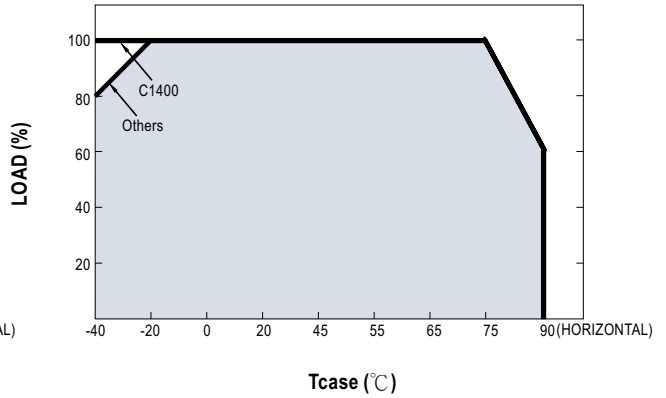
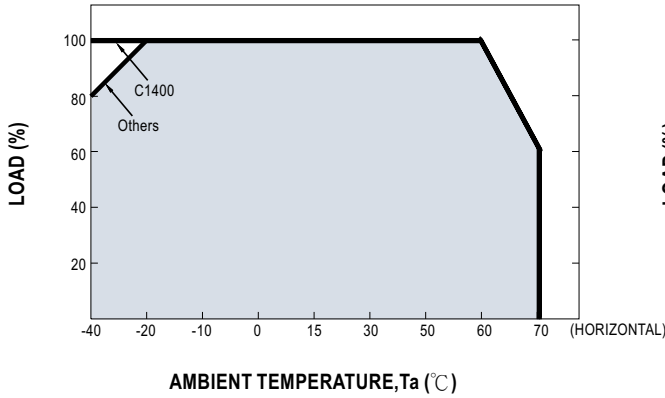

STATIC CHARACTERISTIC

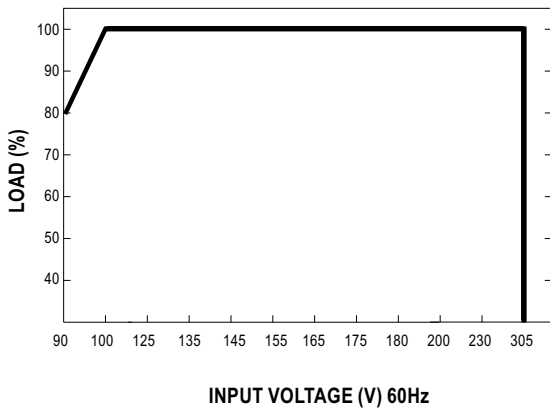

POWER FACTOR (PF) CHARACTERISTIC

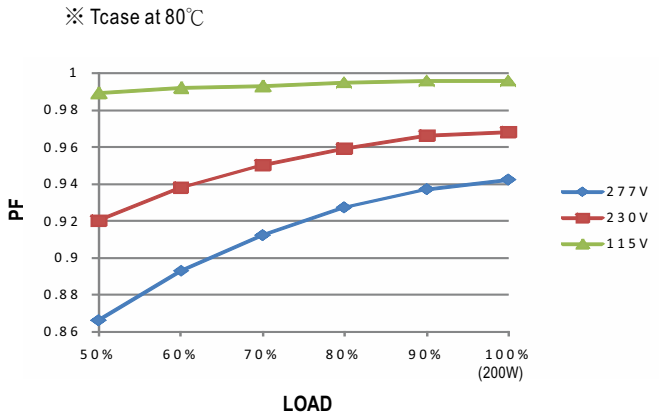

TOTAL HARMONIC DISTORTION (THD)

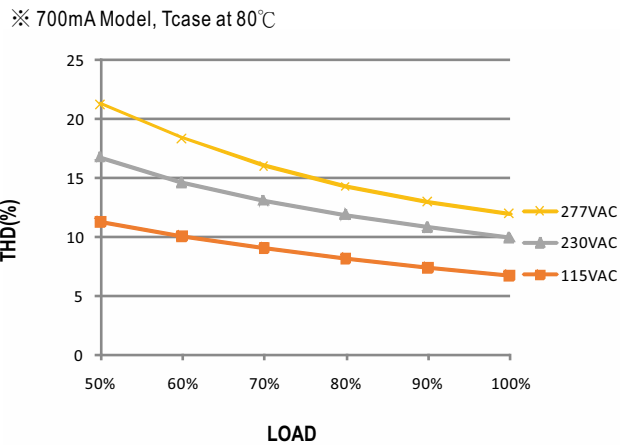

EFFICIENCY vs LOAD

HLG-185H-C series possess superior working efficiency that up to 94% can be reached in field applications.

※ 700mA Model, Tcase at 80°C

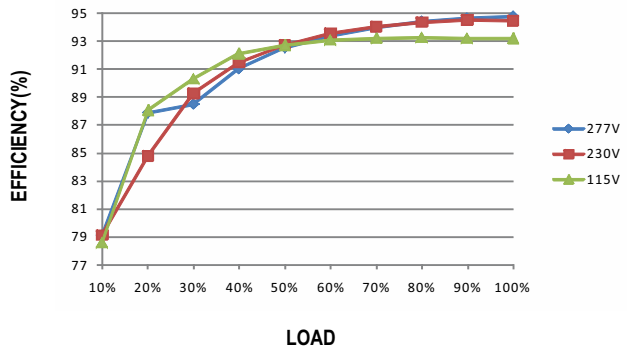



■ LIFE TIME

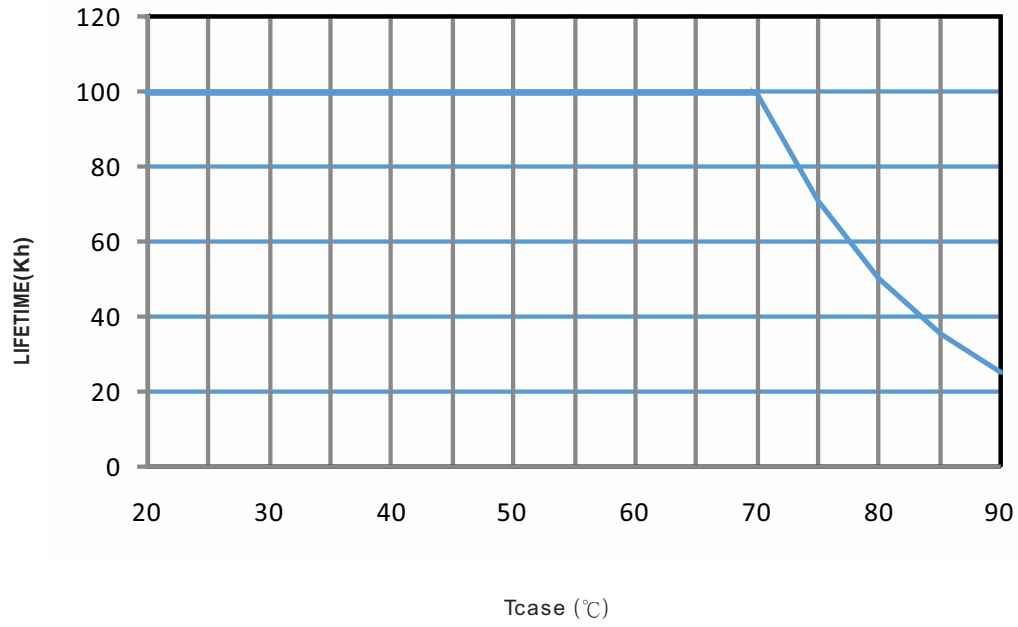

MECHANICAL SPECIFICATION

Case No.994D Unit:mm

※ A-Type

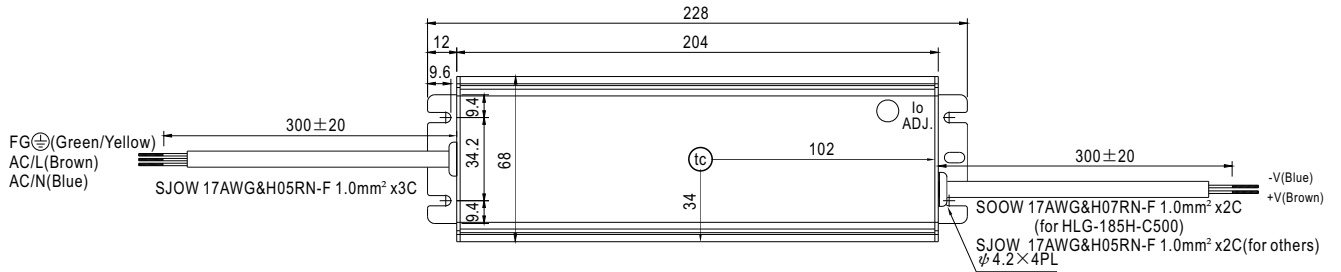

• t_c : Max. Case Temperature



※ B-Type

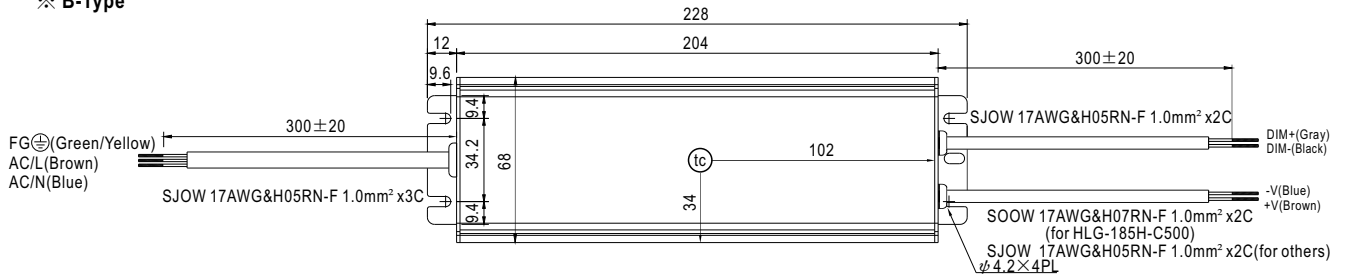

• t_c : Max. Case Temperature

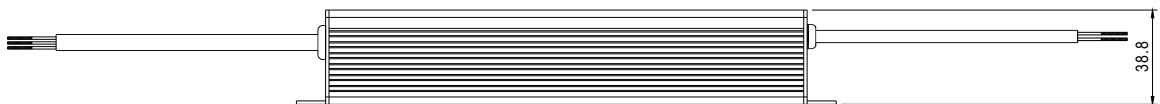

■ WATERPROOF CONNECTION

◎ Waterproof connector

Waterproof connector can be assembled on the output cable of HLG-185H-C to operate in dry/wet/damp or outdoor environment.

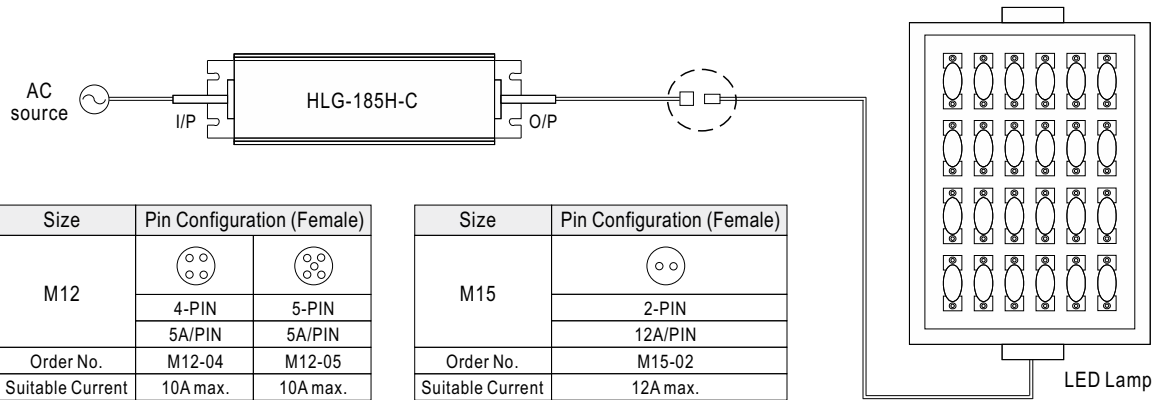

◎ Cable Joiner

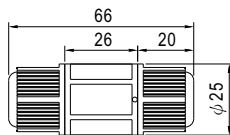

CJ04-1 suitable for 14AWG~16AWG
CJ04-2 suitable for 18AWG~22AWG



Up to four wires can be connected through this cable joiner by soldering or clamping by tools.

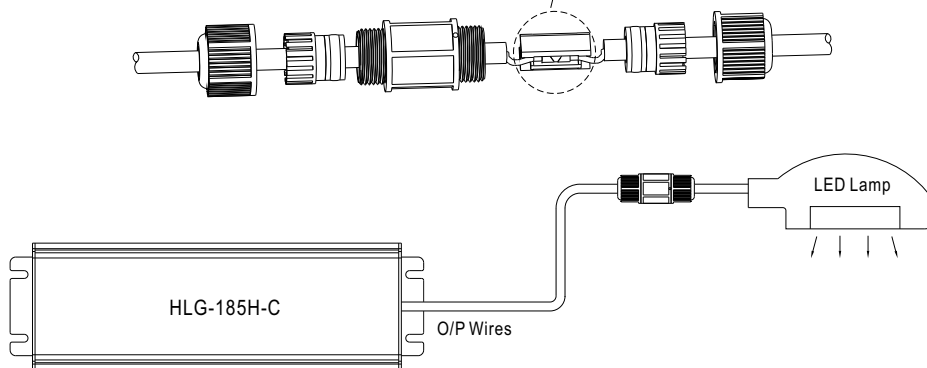

※CJ04 cable joiner can be purchased independently for user's own assembly.
MEAN WELL order No. : CJ04-1, CJ04-2.

■ INSTALLATION MANUAL

Please refer to : <http://www.meanwell.com/manual.html>